

Article number: 20940668A

Description: E+G Clamping bolt
GN 802-M10-54

Measures

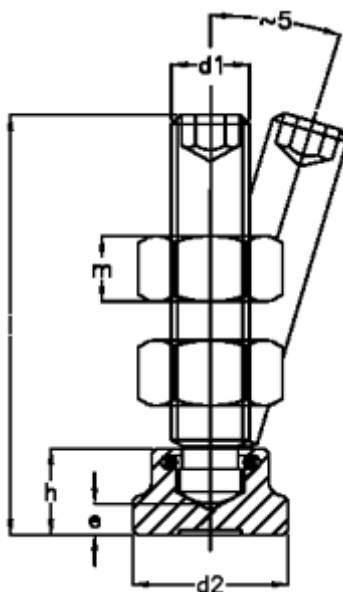

$d1 = M10$

$d2 = 20$

$e = 3,6$

$h = 11$

$l1 = 54$

$m = 8.4$